

Breakover diodes

BR211 series

GENERAL DESCRIPTION

A range of bidirectional, breakover diodes in an axial, hermetically sealed, glass envelope. These devices feature controlled breakover voltage and high holding current together with high peak current handling capability. Typical applications include transient overvoltage protection in telecommunications equipment.

QUICK REFERENCE DATA

SYMBOL	PARAMETER	MIN.	MAX.	UNIT
BR211-140 to 280				
$V_{(BO)}$	Breakover voltage	140	280	V
I_H	Holding current	150	-	mA
I_{TSM}	Non-repetitive peak current	-	40	A

OUTLINE - SOD84

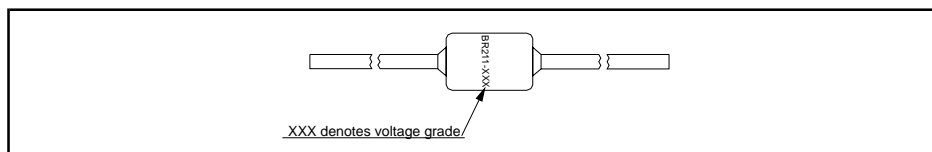

SYMBOL

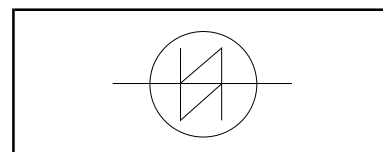

LIMITING VALUES

Limiting values in accordance with the Absolute Maximum System (IEC 134).

SYMBOL	PARAMETER	CONDITIONS	MIN.	MAX.	UNIT
V_D	Continuous voltage		-	75% of $V_{(BO)typ}$	V
I_{TSM1}	Non repetitive peak current	10/320 μ s impulse equivalent to 10/700 μ s, 1.6 kV voltage impulse (CCITT K17)	-	40	A
I_{TSM2}	Non repetitive on-state current	half sine wave; t = 10 ms; $T_j = 70^\circ\text{C}$ prior to surge	-	15	A
I^2t	I^2t for fusing	$t_p = 10$ ms	-	1.1	A^2s
di_T/dt	Rate of rise of on-state current after $V_{(BO)}$ turn-on	$t_p = 10$ μ s	-	50	$\text{A}/\mu\text{s}$
P_{tot}	Continuous dissipation	$T_a = 25^\circ\text{C}$	-	1.2	W
P_{TM}	Peak dissipation	$t_p = 1$ ms; $T_a = 25^\circ\text{C}$	-	50	W
T_{stg}	Storage temperature		-65	150	$^\circ\text{C}$
T_a	Operating ambient temperature	off-state	-	70	$^\circ\text{C}$
T_{vj}	Overload junction temperature	on-state	-	150	$^\circ\text{C}$

Breakover diodes

BR211 series

THERMAL RESISTANCES

SYMBOL	PARAMETER	CONDITIONS	MIN.	TYP.	MAX.	UNIT
$R_{th\ j-e}$	Thermal resistance junction to envelope		-	22	-	K/W
$R_{th\ j-a}$	Thermal resistance junction to ambient	mounted as fig:12	-	105	-	K/W
$Z_{th\ j-a}$	Thermal impedance junction to ambient	$t_p = 1\ ms$	-	2.62	-	K/W
$R_{th\ e-tp}$	Thermal resistance envelope to tie point	lead length = 5 mm	-	15	-	K/W
		lead length = 10 mm	-	30	-	K/W
$R_{th\ e-a}$	Thermal resistance envelope to ambient	lead length = 5 mm	-	440	-	K/W
		lead length = 10 mm	-	350	-	K/W
$R_{th\ tp-a}$	Thermal resistance tie point to ambient	mounted as fig:12	-	70	-	K/W
		mounted with 1 cm ² copper laminate per lead.	-	55	-	K/W
		mounted with 2.25 cm ² copper laminate per lead	-	45	-	K/W

STATIC CHARACTERISTICS

$T_j = 25\ ^\circ C$ unless otherwise stated

SYMBOL	PARAMETER	CONDITIONS	MIN.	TYP.	MAX.	UNIT
V_{TM}^1	On-state voltage	$I_{TM} = 2\ A$	-	-	2.5	V
$V_{(BR)}$	Avalanche voltage (min)	$I_{(BR)} = 10\ mA$				
$V_{(BO)}$	Breakover voltage (max)	$I \leq I_S, t_p = 100\ \mu s$				
		BR211-140	123	140	157	V
		BR211-160	140	160	180	V
		BR211-180	158	180	202	V
		BR211-200	176	200	224	V
		BR211-220	193	220	247	V
		BR211-240	211	240	269	V
		BR211-260	228	260	292	V
		BR211-280	246	280	314	V
						V
						V
$S_{(pr)}$	Temperature coefficient of $V_{(BR)}$		-	+0.1	-	%/K
I_H^2	Holding current	$T_j = 25\ ^\circ C$	150	-	-	mA
		$T_j = 70\ ^\circ C$	100	-	-	mA
I_S^3	Switching current	$t_p = 100\ \mu s$	10	200	1000	mA
I_D^4	Off-state current	$V_D = 85\% V_{(BR)min}, T_j = 70\ ^\circ C$	-	-	10	μA

1 Measured under pulsed conditions to avoid excessive dissipation

2 The minimum current at which the diode will remain in the on-state

3 The avalanche current required to switch the diode to the on-state

4 Measured at maximum recommended continuous voltage. Illuminance $\leq 500\ lux$ (daylight); relative humidity $< 65\%$.

Breakover diodes

BR211 series

DYNAMIC CHARACTERISTICS

$T_j = 25\text{ }^\circ\text{C}$ unless otherwise stated

SYMBOL	PARAMETER	CONDITIONS	MIN.	TYP.	MAX.	UNIT
dV_D/dt	Linear rate of rise of off-state voltage that will not trigger any device	$V_{(DM)} = 85\% V_{(BR)min}; T_j = 70\text{ }^\circ\text{C}$	-	-	2000	V/ μs
C_j	Off-state capacitance	$V_D = 0\text{ V}; f = 1\text{ kHz to } 1\text{ MHz}$	-	-	100	pF

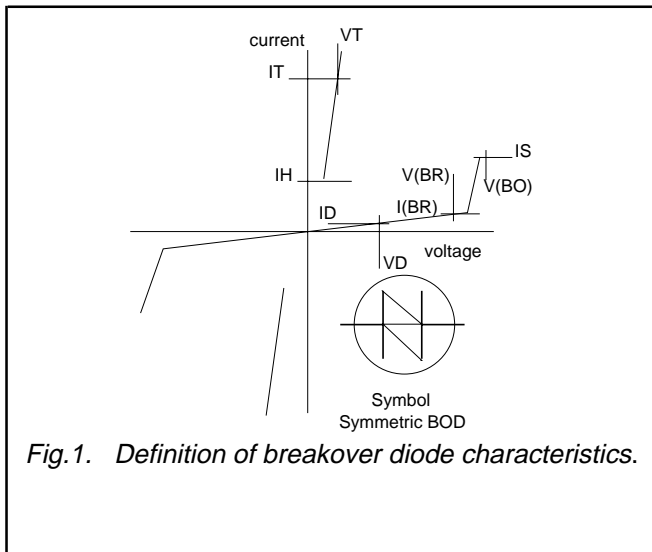

Fig. 1. Definition of breakover diode characteristics.

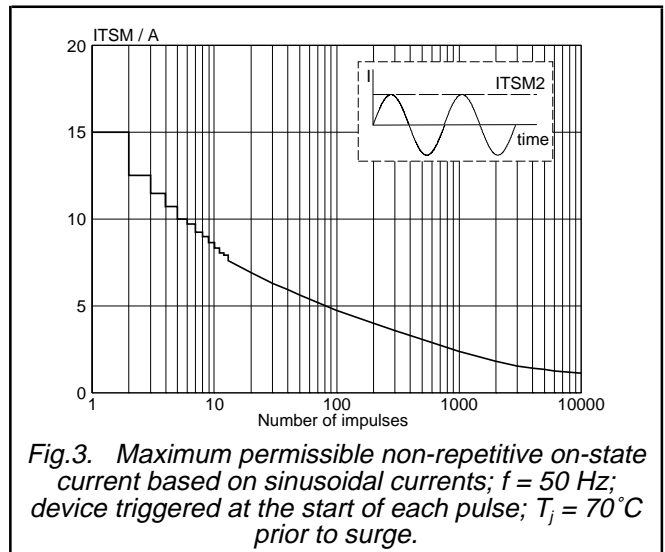

Fig. 3. Maximum permissible non-repetitive on-state current based on sinusoidal currents; $f = 50\text{ Hz}$; device triggered at the start of each pulse; $T_j = 70\text{ }^\circ\text{C}$ prior to surge.

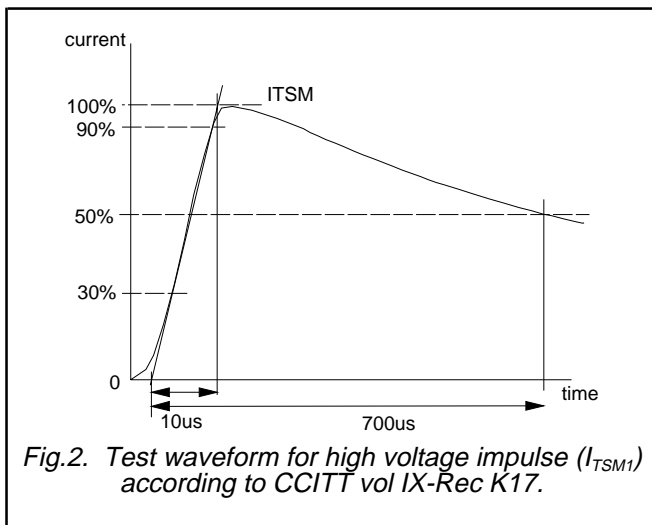

Fig. 2. Test waveform for high voltage impulse (I_{TSM1}) according to CCITT vol IX-Rec K17.

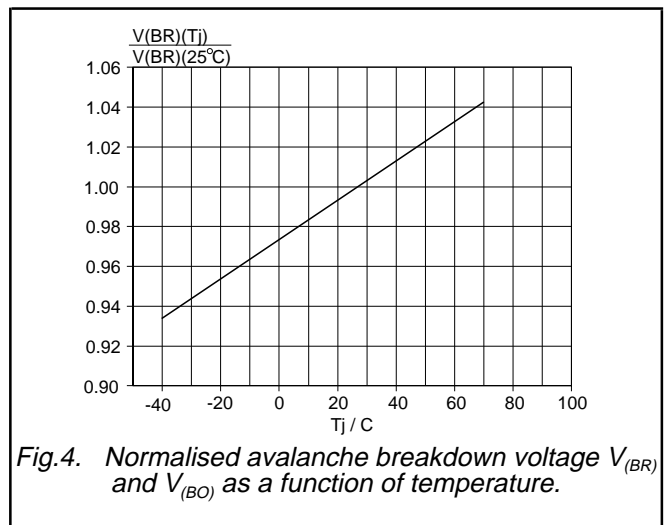
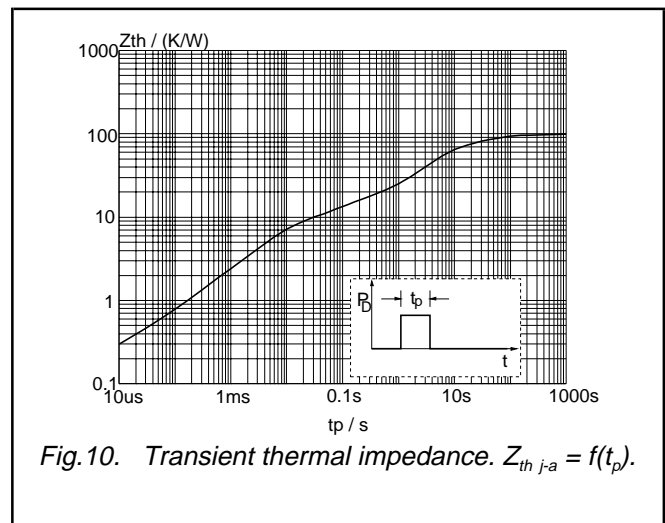
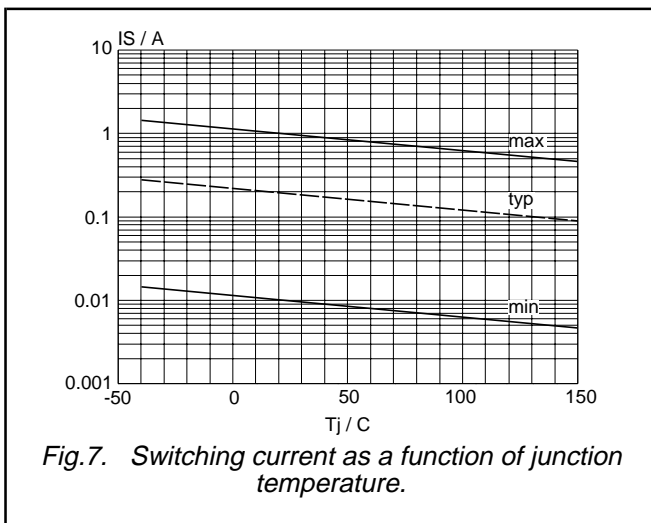
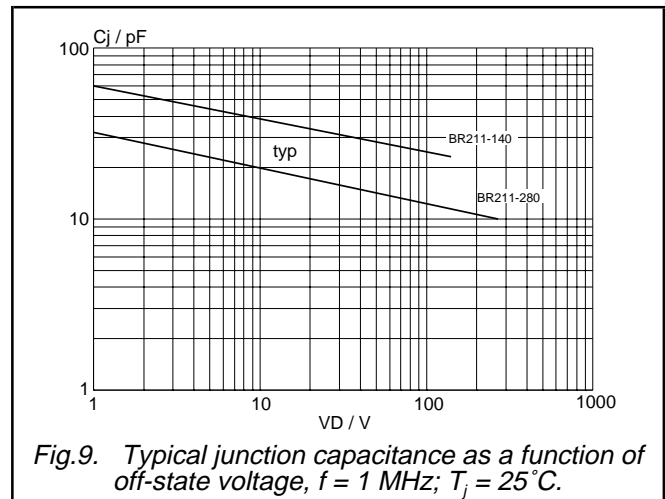
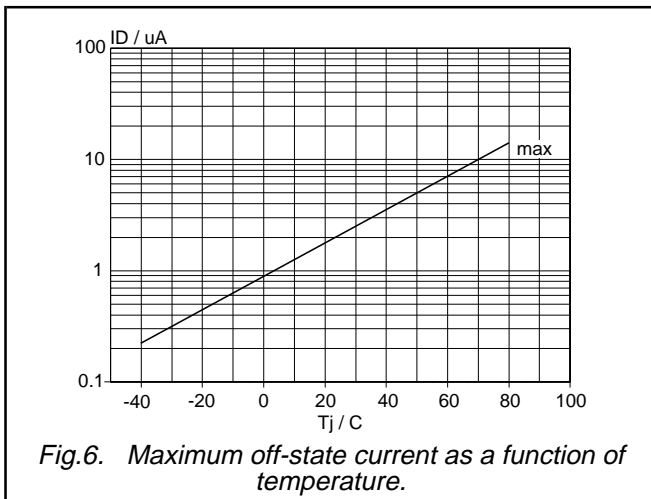
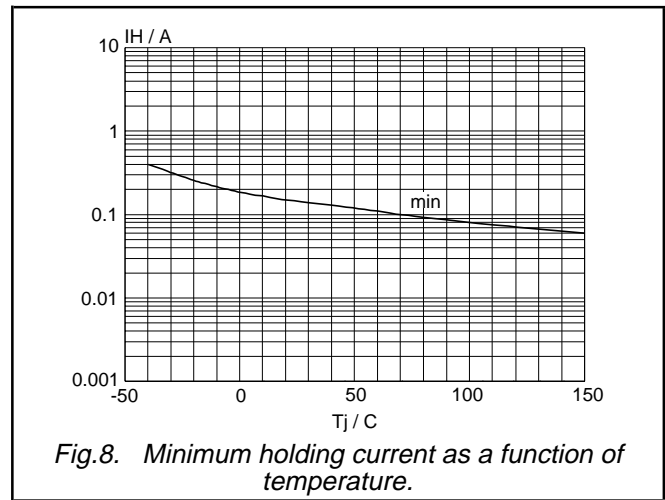
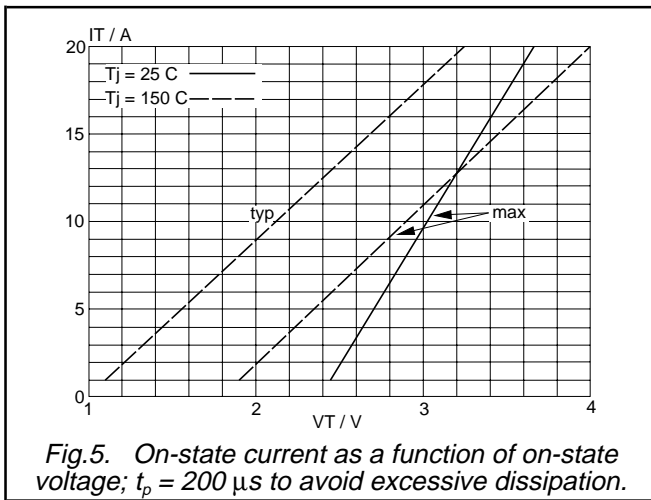

Fig. 4. Normalised avalanche breakdown voltage $V_{(BR)}$ and $V_{(BO)}$ as a function of temperature.

Breakover diodes

BR211 series



Breakover diodes

BR211 series

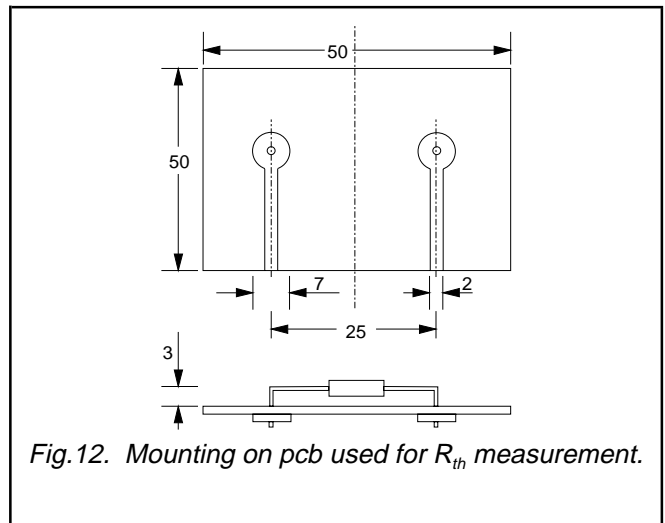
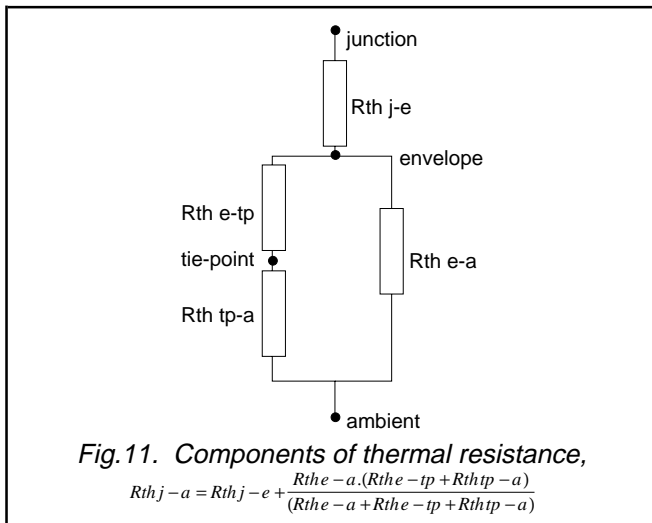

MECHANICAL DATA

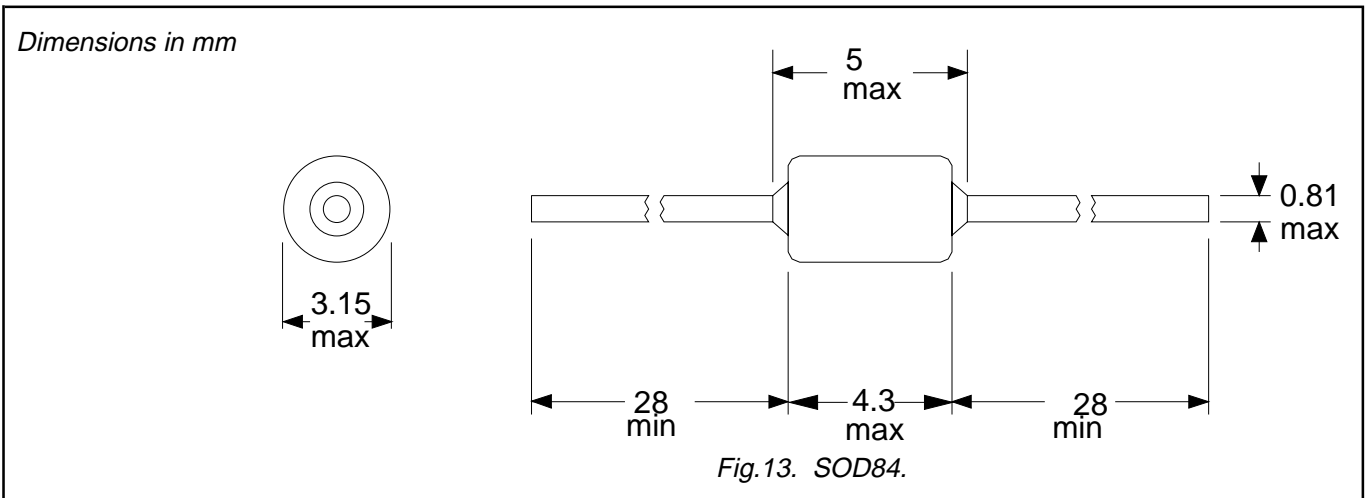

Breakover diodes

BR211 series

DEFINITIONS

Data sheet status	
Objective specification	This data sheet contains target or goal specifications for product development.
Preliminary specification	This data sheet contains preliminary data; supplementary data may be published later.
Product specification	This data sheet contains final product specifications.
Limiting values	
Limiting values are given in accordance with the Absolute Maximum Rating System (IEC 134). Stress above one or more of the limiting values may cause permanent damage to the device. These are stress ratings only and operation of the device at these or at any other conditions above those given in the Characteristics sections of this specification is not implied. Exposure to limiting values for extended periods may affect device reliability.	
Application information	
Where application information is given, it is advisory and does not form part of the specification.	
© Philips Electronics N.V. 1996	
All rights are reserved. Reproduction in whole or in part is prohibited without the prior written consent of the copyright owner.	
The information presented in this document does not form part of any quotation or contract, it is believed to be accurate and reliable and may be changed without notice. No liability will be accepted by the publisher for any consequence of its use. Publication thereof does not convey nor imply any license under patent or other industrial or intellectual property rights.	

LIFE SUPPORT APPLICATIONS

These products are not designed for use in life support appliances, devices or systems where malfunction of these products can be reasonably expected to result in personal injury. Philips customers using or selling these products for use in such applications do so at their own risk and agree to fully indemnify Philips for any damages resulting from such improper use or sale.